

REV.	REVISIONS	DESCRIPTION	DATE	APPROVED

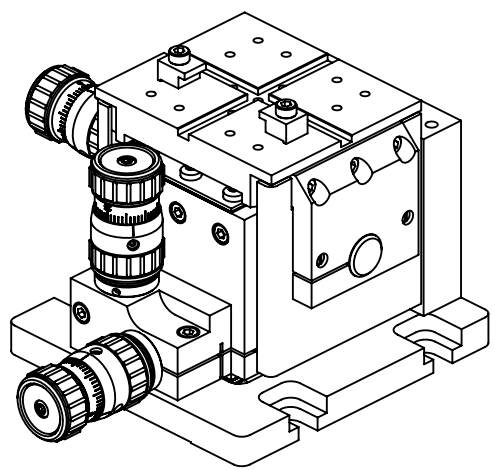

GENERAL VIEW
SCALE: 1:2

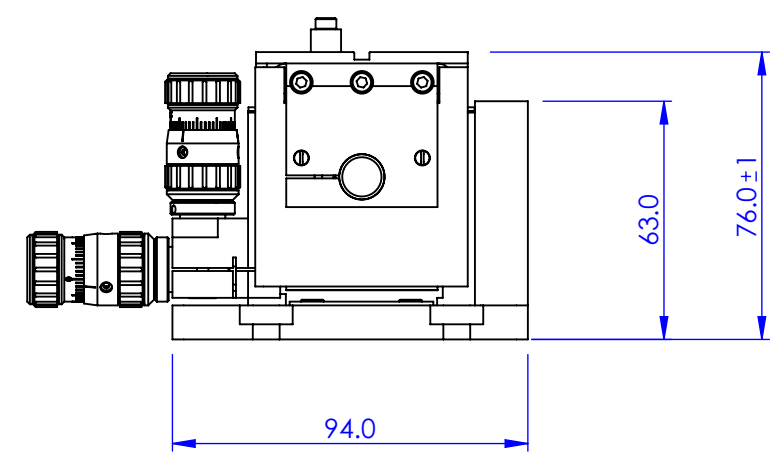
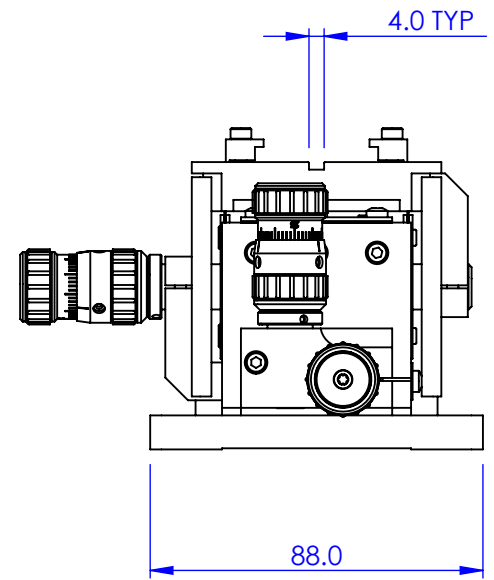
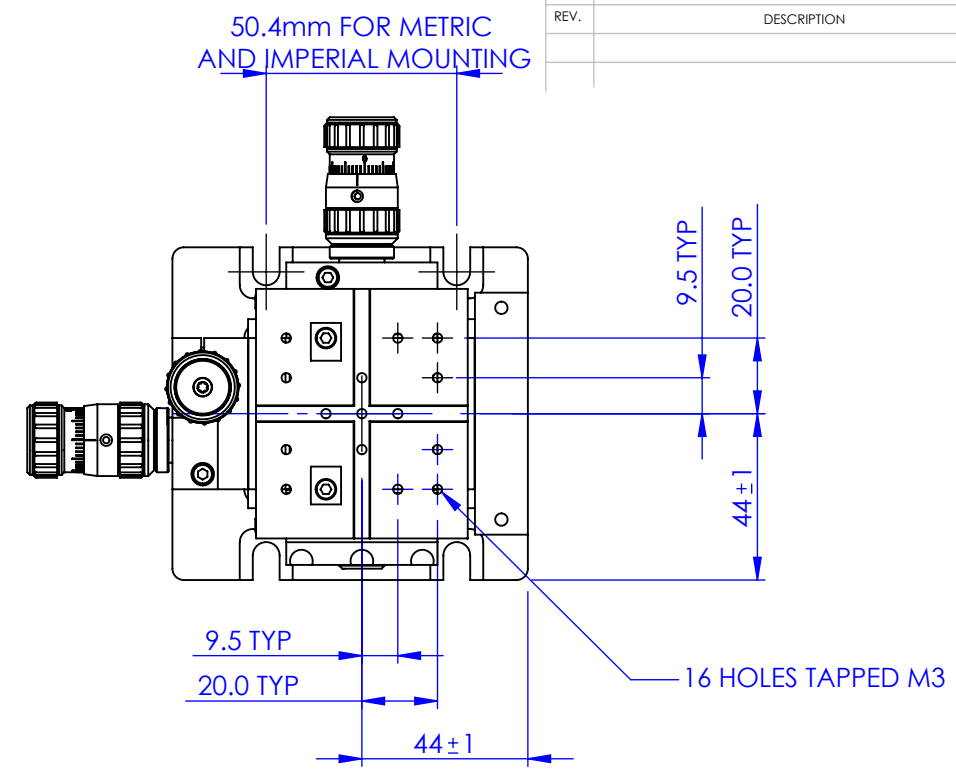

PROPRIETARY AND CONFIDENTIAL
COPYRIGHT ELLIOT SCIENTIFIC Ltd.
 THE INFORMATION CONTAINED IN THIS DRAWING IS THE SOLE PROPERTY OF ELLIOT SCIENTIFIC LTD. REPRODUCTION IN PART OR AS A WHOLE WITHOUT WRITTEN PERMISSION IS PROHIBITED.

DIMENSIONS ARE IN mm
 GENERAL TOLERANCES: ± 0.1
 ANGULAR TOLERANCES: \pm
 SURFACE FINISH:
 ALL BURRS, SHARP EDGES
 AND CORNERS TO BE
 REMOVED

NAME	DATE
AUTHOR GW	30/06/2010
CHECKED --	--
MATERIAL	
FINISH --	
DO NOT SCALE DRAWING	

Elliot Scientific

TITLE
FLEXURE STAGE

SIZE **A4** DWG. NO. **MDE122**

SCALE: 1:2 THIRD ANGLE PROJECTION SHEET 1 OF 1